

Magnetic-Inductive Flow Meter FMI

Application/Specified usage

- Magnetic-inductive flowmeter for the measurement of flow rate and volume in food and pharmaceutical applications
- Suitable for liquids, mash and pastes with a minimum conductivity of $5 \mu\text{S}/\text{cm}$
- Precise measurement of media containing solids ($< 5\%$ solid particle content)
- Measurement range from 30 l/h to 640 000 l/h
- Suitable for dosing and filling applications

Hygienic design/Process connection

- Sensor made entirely of stainless steel
- EHEDG-compliant, hygienic design
- All parts in contact with the product are FDA-compliant
- Conforming to 3-A Sanitary Standard with process connection SS, TC and HH
- Transmitter made of PFA; vacuum-tight and piggable
- Process connection made of stainless steel 1.4404, optionally 1.4435 with inspection certificate 3.1
- Process connection optionally with $R_a \leq 0.4 \mu\text{m}$, electropolished
- Electrodes made of stainless steel 1.4404 with inspection certificate 3.1
- CIP-/SIP-cleaning up to max. 130°C (max. 30 minutes)
- Large selection of process adapters

Special features/Advantages

- High measurement accuracy even at low flow rates
- Simple and user-friendly parameterization
- Automatic empty pipe detection avoids undefined readings for empty pipes
- PFA lining for maximum resistance to aggressive substances such as acids and bases
- Vacuum-tight, rigid meter tube lining, even at high temperatures
- Swiveling housing head with illuminated graphic display
- Operation of device via optical keys without opening the housing
- Minimal maintenance and care requirements
- Pharmaceutical version available with all necessary certificates

Functional principle

The principle behind this measurement method is Faraday's law of induction.

This law states that a voltage is induced in a conductor that moves in a magnetic field. In the magnetic-inductive measurement method, the flowing, conductive medium acts as the conductor. Two vertically positioned field coils generate a constant magnetic field. The voltage induced in the flowing medium is measured by two stainless steel electrodes that are arranged horizontally. The voltage is directly proportional to the flow rate and can be expressed as the flow volume using the nominal tube width. The determined measurement values are made available as a counting pulse and 4...20 mA standard signal.

Certification



FMI flowmeter



Magnetic-inductive measurement

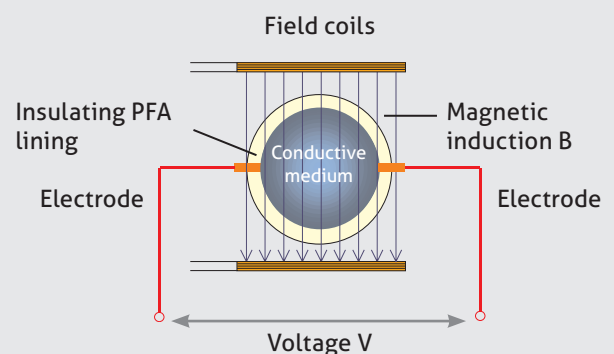

Display

- Integrated graphic display, illuminated
- Display surface swivels 4 x 90°
- Operation via optical keys (housing does not need to be opened)
- User guidance in English/German (switchable)

Bus systems

- CS3 / RS485
- Profibus DP (option)

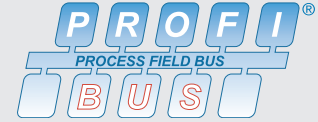
**Outputs/Inputs**

- 3 digital outputs for volume pulse and status signal
- 1 digital signal input for zero setting, measurement interruption (CIP) or measurement start

Electrical connection

Cable screw connection or M12 plug

Supply voltage

Supply voltage
9...32 V DC or
100...240 V AC

Measurement transmitter

- DN 10 ... DN 150
- PFA liner, vacuum-tight, piggable, FDA-approved
- Measurement electrodes, 1.4404 with inspection certificate 3.1

Switch converter

Continuously rotatable measurement head

Meter tube

Universal DIN 11864 aseptic flange

- Tube standards
- DIN 11850 Series 2
 - OD tube (ASME BPE)
 - DIN 11866 Series A, B, C

**Note**

The display comes with a power saving mode. The background lighting automatically switches off after 30 minutes, while the measured values continue to be displayed. For better readability, however, the lighting can be switched on again at any time by pressing the optical keys.

Pharmaceutical version

For pipe connections DIN 11866 Series A, B, C
Material 1.4435 with inspection certificate 3.1
USP Class VI for PFA lining and seal

Optional:



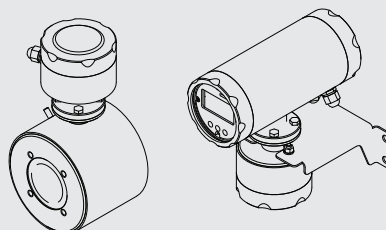

- Surface $R_a \leq 0.4 \mu\text{m}$ electropolished
- Measurement report for surface roughness and delta ferrite content

Separate version



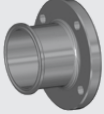
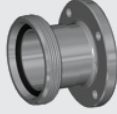
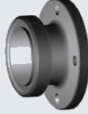

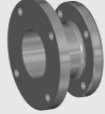

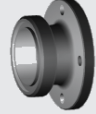
Cable length: 5 or 10 meters



Process adapters

							
Weld flange	Tri-Clamp	Milk pipe fitting	Aseptic fitting	Varivent	FG hygienic flange	DIN flange	SMS threaded connector

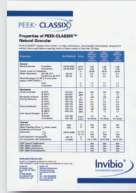
Certificates

							
2.2 EN 10204	3.1 EN 10204	Calibration certificate	3-A	USP Class VI	Surface		

Conditions for a measuring point according to 3-A Sanitary Standard 28-04



- The sensor FMI conforming to the 3-A Sanitary Standard with process connection SS, TC and HH.
- The sensor is designed for CIP-/ SIP-cleaning. Maximum 130 °C / 30 minutes.
- Mounting position, self draining and the position of the leakage hole must be in accordance to current 3-A Sanitary Standard.
- At sensors with weld flange the weld must comply to the requirements of the current 3-A Sanitary Standard.

Notes

Technical data		
Transmitter	Measurement ranges Nominal width	0.1...10 m/s DN10...DN150 1/2"...4"
Process connection	Transmitter Tube standards Process adapters	Aseptic flange DIN 11864-2, Form A Inside diameter as per DIN 11850 Series 2 Food: DIN 11850 Series 2, OD Tube (ASME BPE) Pharma: DIN 11866 Series A, B, C See pages 8 and 9
Materials	Pipe connection Seal Transmitter housing Transmitter lining Electrodes Converter housing Cap with control window M12 plug Cable gland	Food: 1.4404; Pharma: 1.4435 with 3.1 certificate Food: EPDM, FDA-compliant Pharma: EPDM with USP Class VI 1.4301 (blasted) PFA (FDA approval number 21 CFR 177.1550) 1.4404 with 3.1 certificate 1.4404 PMMA (acrylic glass) 1.4305 1.4305
Temperature ranges	Environment / Storage Compact design Remote design	DC: -20...+55 °C AC: -20...+45 °C Process: 0...+100 °C / CIP / SIP cleaning: up to 130 °C max. 30 min Process: 0...+165 °C
Transmitter	LCD display Electrical connection Supply voltage Power consumption Fuse protection	Graphic LCD, 46 mm x 23 mm, back-lit Cable gland Option: M12 plug (DC version only) DC: 9...32 V DC AC: 100...240 V AC, 50...60 Hz -15 %/+10 % Max. 10 VA/8 watt DC: T 1.5 A AC: 500 mA
Connection cables (remote version only)	Electrode cable Coil cable Cable length	LIYCY-0, 4 x 0.5 mm ² , screened F-CY-OZ, 2 x 0.5 mm ² , screened 5 m (standard), 10 m (option)
Measurement accuracy	Reproducibility	±0.2 % ±1 mm/s, under reference conditions as per DIN EN 29104 and VDI/VDE 2641 ±0.05 % ±0.5 mm/s
Product conductivity	Compact version Remote version	> 5 µS/cm, for demineralized water > 20 µS/cm > 15 µS/cm, for demineralized water > 30 µS/cm
Pulse output (volume counter)	2 x optocoupler, passive	32 V / 20 mA, pulse sequence max. 1 kHz (with option "M12-plug" only one pulse output connected)
Analog output (flow rate)	Active/passive selectable Load resistance	(0)/4...20 mA Max. 500 Ω
Status output	1 x optocoupler, passive	32 V / 20 mA (fault or direction of flow)
Status input	1 x optocoupler, passive	9...32 V, R _i < 3.2 kΩ
Interface	Field bus	CS3-Bus/RS485 Option: Profibus DP (DC version only)
Operating pressure	PN10	0.1...11 bar absolute (vacuum-tight)
Protection class		IP 65



Note

This product information is not an operating manual. Please note the information on device safety, installation and operation in the product operating manual.

Measurement accuracy by flow rate

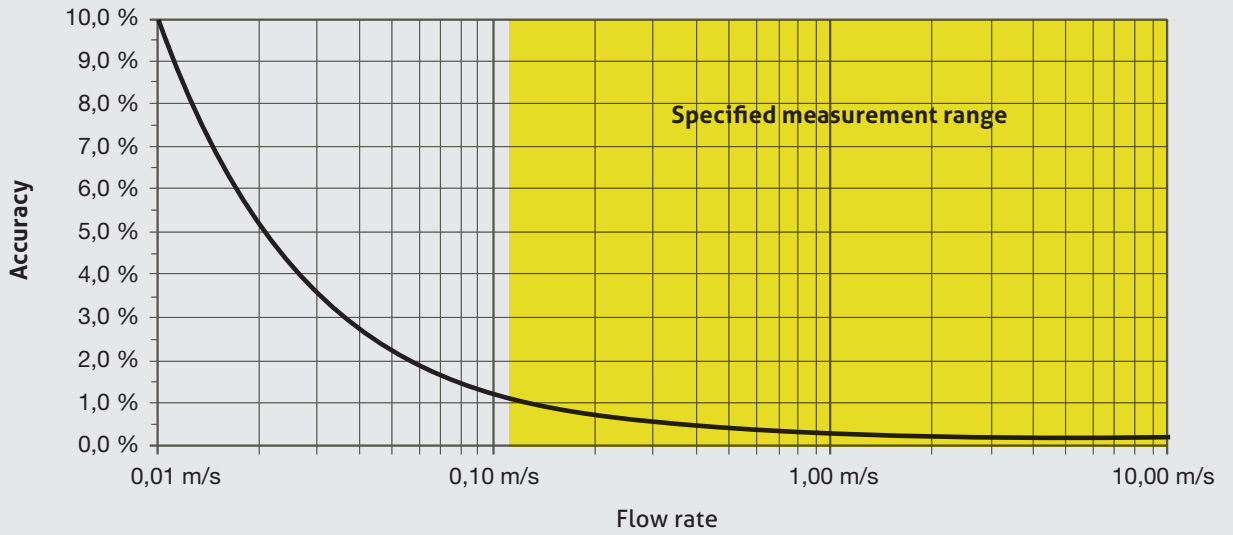

Flow rate nomogram

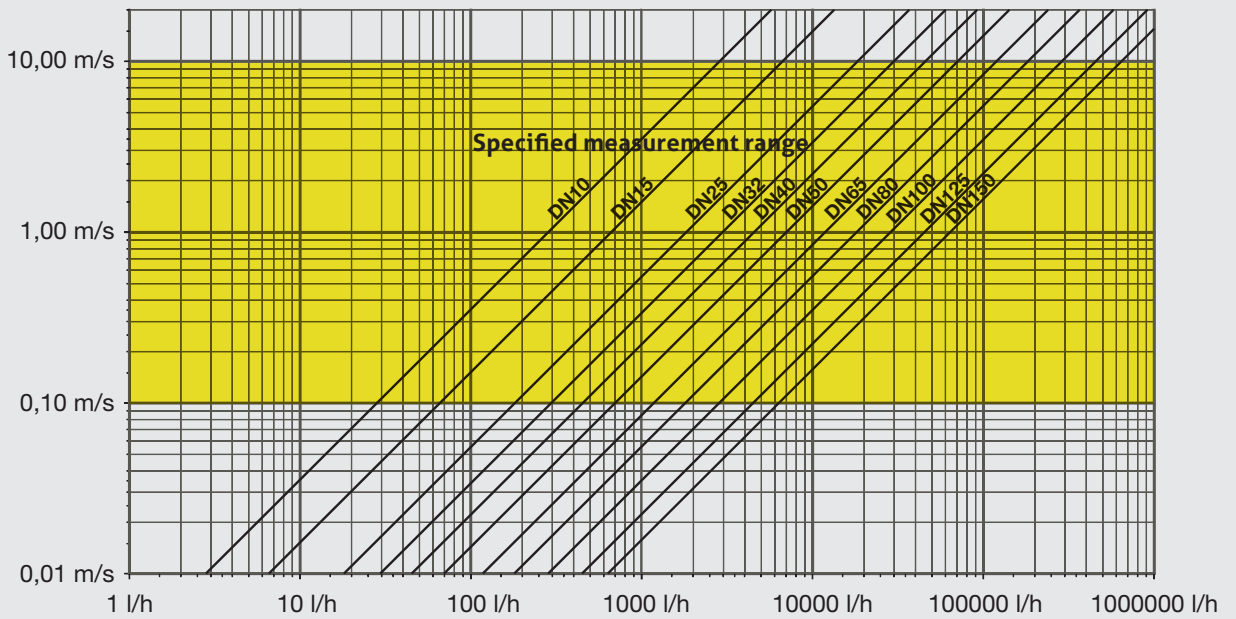

FMI-C dimensional drawing

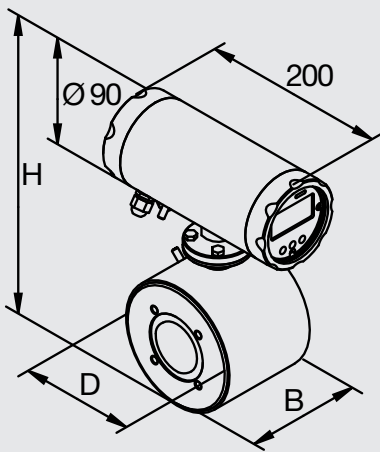

FMI-C dimensions, incl. measurement range and weight

Nominal width DN	B [mm]	H [mm]	D [mm]	Measurement range [l/h]	Weight [kg] *	
					Compact design	
10	104	225	90	30...3.000	6	
15	104	225	90	70...7.000	6	
25	104	225	90	180...18.000	6	
32	104	240	105	300...30.000	7	
40	104	240	105	450...45.000	7	
50	104	265	130	700...70.000	8	
65	160	265	130	1.200...120.000	8	
80	160	290	155	1.800...180.000	12	
100	200	305	170	2.800...280.000	17	
125	110	355	220	4.400...440.000	22	
150	140	355	220	6.400...640.000	25	

*) without process connections

FMI-R dimensional drawing

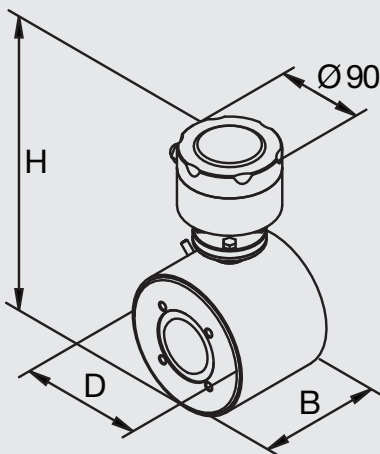

FMI-R dimensions, incl. measurement range and weight

Nominal width DN	B [mm]	D [mm]	H [mm]	Measurement range [l/h]	Weight [kg] *	
					Remote design (measuring feeder)	Transmitter and converter (display unit)
10	104	90	201	30...3.000	4	5
15	104	90	201	70...7.000	4	5
25	104	90	201	180...18.000	4	5
32	104	105	216	300...30.000	5	5
40	104	105	216	450...45.000	5	5
50	104	130	241	700...70.000	6	5
65	160	130	241	1.200...120.000	6	5
80	160	155	266	1.800...180.000	10	5
100	200	170	281	2.800...280.000	15	5
125	110	220	331	4.400...440.000	20	5
150	140	220	331	6.400...640.000	23	5

*) without process connections

FMI-R dimensional drawing, installation dimensions

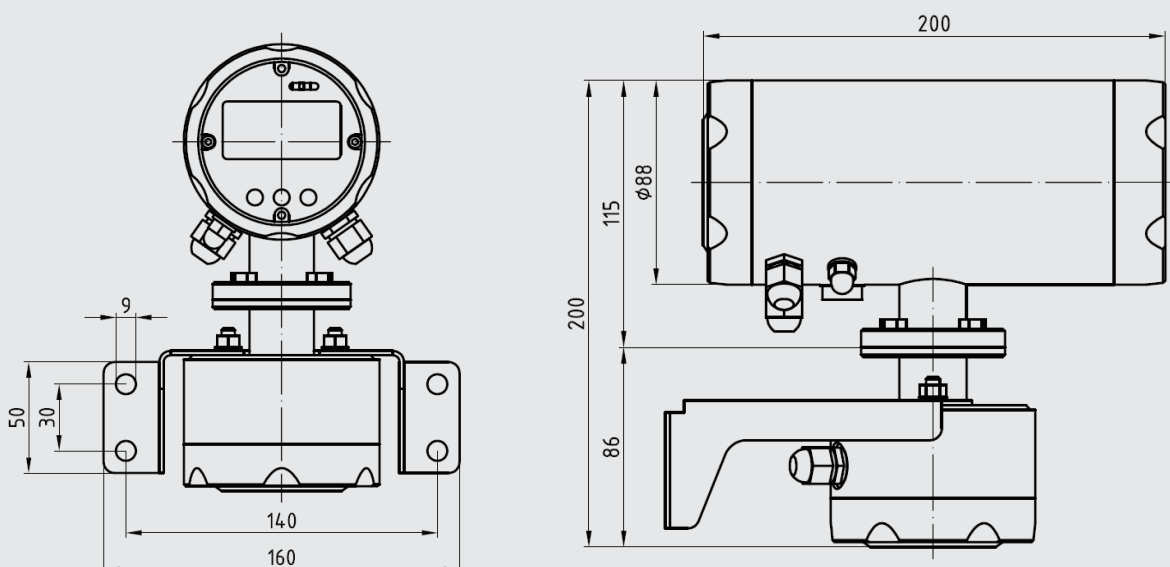

Installation length

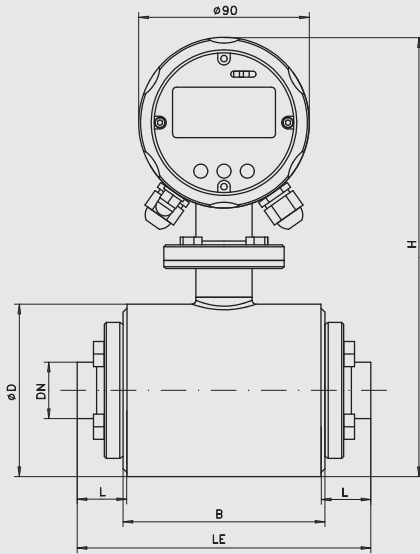

L = fitting length
LE = installation length
LE = B - 3 mm + 2 x L

Note



Dimensions "B" of transmitters DN65, DN80 and DN100 have changed effective from production date as of June 2012.

Transmitter	B (old)	B (new, as of 01.06.2012)
DN65	104	160
DN80	105	160
DN100	110	200

Main application area: Food | Material: 1.4404

DIN11850 Series 2									
installation length LE									
Transmitter \varnothing	Pipe DN	Pipe size OD x WT [mm]	Weld flange	Tri-Clamp DIN 32676 (* Tri-Clamp size)	Threaded connector DIN 11851 (milk pipe)	Aseptic fitting DIN 11864-1 (threaded side)	DIN flange DIN EN 1092-1 (type 11, Form B)	VARIVENT smooth flange	FG hygienic flange
10	10	13 x 15	152	200 (TC34)*	200	190	200	-	-
15	15	19 x 1.5	152	200 (TC34)*	200	190	200	-	-
25	25	29 x 1.5	152	200 (TC50)*	200	204	225	-	200
32	32	35 x 1.5	152	200 (TC50)*	200	212	-	200	-
40	40	41 x 1.5	152	200 (TC50)*	200	214	225	-	200
50	50	53 x 1.5	152	200 (TC64)*	200	214	225	200	200
65	65	70 x 2.0	208	256 (TC91)*	256	280	306	256	256
80	80	85 x 2.0	212	256 (TC106)*	256	296	305	256	255
100	100	104 x 2.0	252	340 (TC119)*	-	352	340	-	340
125	125	129.0 x 2.0	166	-	-	-	-	-	220
150	150	154.0 x 2.0	196	-	-	-	-	-	250

Main application area: Food | Material: 1.4404

OD-Tube (ASME-BPE)					
installation length LE					
Transmitter \varnothing	Pipe DN	Pipe size OD x WT [mm]	Weld flange ASME BPE	Tri-Clamp ASME BPE (* Tri-Clamp size)	SMS threaded connector
10	1/2"	12.7 x 1.65	152	209 (TC25)*	-
15	3/4"	19.05 x 1.65	152	209 (TC25)*	-
25	1"	25.4 x 1.65	152	224 (TC50)*	182
32	-	-	-	-	-
40	1 1/2"	38.1 x 1.65	152	224 (TC50)*	192
50	2"	50.8 x 1.65	152	224 (TC64)*	192
65	2 1/2"	63.5 x 1.65	208	280 (TC77)*	256
80	3"	76.2 x 1.65	212	308 (TC91)*	260
100	4"	101.6 x 2.11	252	348 (TC119)*	312

Main application area: Pharmaceutical | Material: 1.4435 with 3.1 certificate

Transmitter Ø	DIN 11866 Series A				DIN 11866 Series B			
	Pipe DN	Pipe size OD x WT [mm]	installation length LE		Pipe DN	Pipe size OD x WT [mm]	installation length LE	
			Weld flange	Tri-Clamp DIN 32676 (* Tri-Clamp size)			Weld flange	Tri-Clamp DIN 32676 (* Tri-Clamp size)
10	10	13 x 1.5	152	209 (TC34)*	8	13.5 x 1.6	152	209 (TC25)*
15	15	19 x 1.5	152	209 (TC34)*	10	17.2 x 1.6	152	224 (TC25)*
25	25	29 x 1.5	152	224 (TC50)*	20	26.9 x 1.6	152	224 (TC50)*
32	32	35 x 1.5	152	224 (TC50)*	25	33.7 x 2.0	152	224 (TC50)*
40	40	41 x 1.5	152	224 (TC50)*	32	42.4 x 2.0	152	224 (TC64)*
50	50	53 x 1.5	152	224 (TC64)*	40 50	48.3 x 2.0 60.3 x 2.0	152	224 (TC64)* 224 (TC77)*
65	65	70 x 2.0	208	304 (TC91)*	65	76.1 x 2.0	208	280 (TC91)*
80	80	85 x 2.0	212	308 (TC106)*	80	88.9 x 2.3	212	304 (TC106)*
100	100	104 x 2.0	252	348 (TC119)*	-	-	-	-

Main application area: Pharmaceutical
Material: 1.4435 with 3.1 certificate

Transmitter Ø	DIN 11866 Series C			
	Pipe DN	Pipe size OD x WT [mm]	installation length LE	
			Weld flange	Tri-Clamp ASME BPE (* Tri-Clamp size)
10	1/2"	12.7 x 1.65	152	209 (TC25)*
15	3/4"	19.05 x 1.65	152	209 (TC25)*
25	1"	25.4 x 1.65	152	224 (TC50)*
32	-	-	-	-
40	1½"	38.1 x 1.65	152	224 (TC50)*
50	2"	50.8 x 1.65	152	224 (TC64)*
65	2½"	63.5 x 1.65	208	280 (TC77)*
80	3"	76.2 x 1.65	212	308 (TC91)*
100	4"	101.6 x 2.11	252	348 (TC119)*

Weld flange

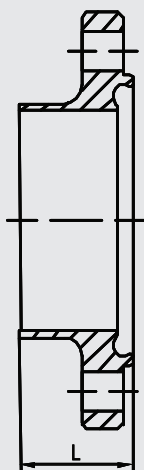

DN	L [mm]
10	25.5
15	25.5
25	25.5
32	25.5
40	25.5
50	25.5
65	25.5
80	27.5
100	27.5
125	29.5
150	29.5

Tri-Clamp

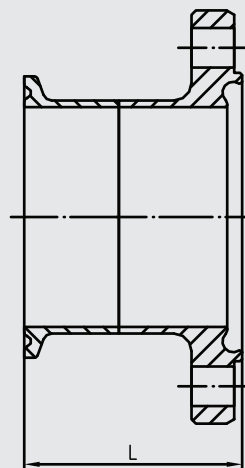

DN	L [mm] (DINA, DINB)	L [mm] (ASME, DINC)
10	49.5	54.1
15	49.5	54.1
25	49.5	61.5
32	49.5	-
40	49.5	61.5
50	49.5	61.5
65	49.5	61.5
80	49.5	75.5
100	71.5	75.5
125	-	-
150	-	-

Milk pipe fitting DIN 11851

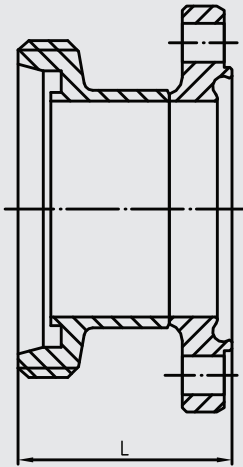

DN	L [mm]
10	49.5
15	49.5
25	49.5
32	49.5
40	49.5
50	49.5
65	49.5
80	49.5
100	-
125	-
150	-

Aseptic fitting 11864

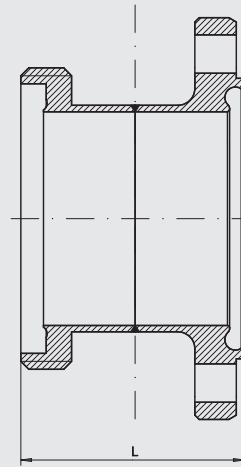

DN	L [mm]
10	44.5
15	44.5
25	51.5
32	55.5
40	56.5
50	56.5
65	61.5
80	69.5
100	77.5
125	-
150	-

VARIVENT

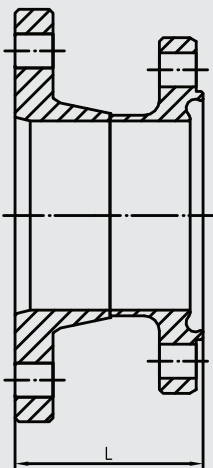

DN	L [mm]
10	-
15	-
25	-
32	49.5
40	-
50	49.5
65	49.5
80	49.5
100	-
125	-
150	-

FG hygienic flange

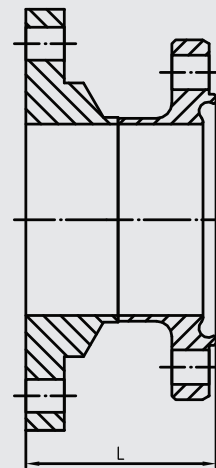

DN	L [mm]
10	-
15	-
25	49.5
32	-
40	49.5
50	49.5
65	49.5
80	49
100	71.5
125	56.5
150	56.5

DIN flange

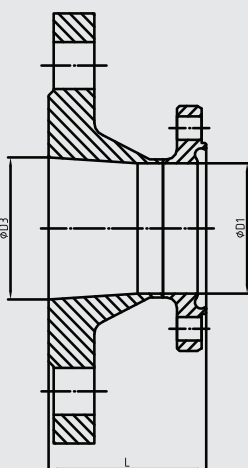

DN	L [mm]	D1 [mm]	D3 [mm]
10	49.5	10	13.6
15	49.5	16	17.3
25	62	26	28.5
32	-	-	-
40	62	38	43.1
50	62	50	54.5
65	74.5	66	70.3
80	74	81	82.3
100	71.5	100	107.1
125	-	-	-
150	-	-	-

SMS threaded connector

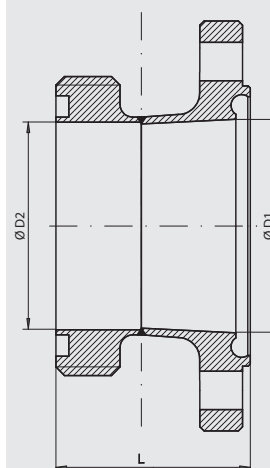

DN	D1 [mm]	D2 [mm]	L [mm]
10	-	-	-
15	-	-	-
25	26	22.5	40.5
32	-	-	-
40	38	35.5	45.5
50	50	48.5	45.5
65	66	60.5	49.5
80	81	73.1	51.5
100	100	97.6	57.5
125	-	-	-
150	-	-	-

Main application area: Food | Material: 1.4404 (without 3.1 certificate)

FMI-C compact version
 FMI-R remote version (includes 5 m coil and electrode cable as standard)

Tube standard

DIN2 DIN11850 Series 2 - Main application area: Food - Material: 1.4404

ODT OD-Tube OD Tube (ASME-BPE) - Main application area: Food - Material: 1.4404

Nominal diameter Process connection

DIN2	ODT
10	1/2"
15	3/4"
25	1"
32	-
40	1½"
50	2"
65	2½"
80	3"
100	4"
125	-
150	6"

Process connection

SS (weld flange)
 TC (Tri-Clamp)*
 HH (aseptic fitting DIN 11864-1 threaded side)
 GG (milk pipe fitting DIN 11851)
 VN (VARIVENT smooth flange)
 FG (FG hygienic flange, smooth flange)
 DF (DIN flange as per DIN EN 1092-1 Type 11 Form B, similar to DIN 2623/2633)
 SMS (SMS threaded connector)

DIN 11850 Series 2

DIN2	SS	TC	GG	HH	DF	VN	FG
10	x	x	x	x	x		
15	x	x	x	x	x		
25	x	x	x	x	x		x
32	x	x	x	x		x	
40	x	x	x	x	x		x
50	x	x	x	x	x	x	x
65	x	x	x	x	x	x	x
80	x	x	x	x	x	x	x
100	x	x		x	x		x
125	x						x
150	x						x

OD-Tube (ASME BPE)

ODT	SS	TC	SMS
1/2"	x	x	
3/4"	x	x	
1"	x	x	x
-			
1½"	x	x	x
2"	x	x	x
2½"	x	x	x
3"	x	x	x
4"	x	x	x
-			
6"			

x = process connection available for nominal width

Field bus (DC version only)

X (without field bus connection)
 DP (Profibus DP)

Power supply

DC (9...32 V DC)
 AC (100...240 V AC)

Electrical connection (DC version only)

X (cable gland, not with Profibus DP)
 M12 (M12-plug)

FMI-C / DIN2 / 40 / SS / DP / DC / M12

* Dimensions see table on page 7.

Main application area: Pharmaceutical | Material: 1.4435 with 3.1 certificate

FMI-C compact version
 FMI-R remote version (includes 5 m coil and electrode cable as standard)

Tube standard

DINA DIN11866 Series A (pipe size as per DIN11859 Series 2)
 DINB DIN11866 Series B (pipe size as per DIN EN ISO 1127)
 DINC DIN11866 Series C (pipe size as per ASME-BPE)

Nominal diameter Process connection

DINA	DINB	DINC
10	08	1/2"
15	10	3/4"
25	15	1"
32	25	-
40	32	1½"
50	40	2"
65	50	2½"
80	65	3"
100	80	4"
125	-	-
150	-	6"

Process connection

SS (weld flange)
 TC (Tri-Clamp)*

DIN 11866 Series A

DINA	SS	TC
10	x	x
15	x	x
25	x	x
32	x	x
40	x	x
50	x	x
65	x	x
80	x	x
100	x	x

DIN 11866 Series B

DINB	SS	TC
08	x	x
10	x	x
15	x	x
25	x	x
32	x	x
40	x	x
50	x	x
65	x	x
80	x	x

DIN 11866 Series C

DINC	SS	TC
1/2"	x	x
3/4"	x	x
1"	x	x
-		
1½"	x	x
2"	x	x
2½"	x	x
3"	x	x
4"	x	x

x = process connection available for nominal width

Surface quality (wetted parts, except weldseam)

X (Surface $R_a \leq 0.8 \mu\text{m}$)
 04 (Surface electro-polished, $R_a \leq 0.4 \mu\text{m}$)

Field bus (DC version only)

X (without field bus connection)
 DP (Profibus DP)

Power supply

DC (9...32 V DC)
 AC (100...240 V AC)

Electrical connection (DC version only)

X (cable gland, not with Profibus DP)
 M12 (M12-plug)

FMI-C / DINA / 40 / SS / 04 / DP / DC / M12

* Dimensions see table on page 8.

FMI replacement electronics

FMI-CE replacement electronics for compact version "FMI-C"
FMI-RE replacement electronics for remote version "FMI-R"

Field bus (DC version only)

X (without field bus connection)
DP (Profibus DP)

Power supply

DC (9...32 V DC)
AC (100...240 V AC)

Electrical connection (DC version only)

X (cable gland, not with Profibus DP)
M12 (M12 plug)

FMI-CE / X / DC / M12

Coil and electrode cables for remote version FMI-R

LIY-CY / 2x0.5G-5 m	coil cable, type 2 x 0.5 mm ² F-CY-OZ (LIY-CY), for FMI-R, 5 m, screened
LIY-CY / 2x0.5G-10 m	coil cable, type 2 x 0.5 mm ² F-CY-OZ (LIY-CY), for FMI-R, 10 m, screened
LIY-CY / 4x0.5G-5 m	electrode cable, type 4 x 0.5 mm ² F-CY-OZ (LIY-CY), for FMI-R, 5 m, screened
LIY-CY / 4x0.5G-10 m	electrode cable, type 4 x 0.5 mm ² F-CY-OZ (LIY-CY), for FMI-R, 10 m, screened

Note



The standard scope of delivery of the FMI-R contains a 5 m coil and electrode cable.

Accessories

PVC-cable with M12-connection made of 1.4305, IP 69 K, unshielded

M12-PVC / 4-5 m	PVC-cable 4-pin, length 5 m
M12-PVC / 4-10 m	PVC-cable 4-pin, length 10 m
M12-PVC / 4-25 m	PVC-cable 4-pin, length 25 m
M12-PVC / 5-5 m	PVC-cable, 5-pin, length 5 m
M12-PVC / 5-10 m	PVC-cable, 5-pin, length 10 m
M12-PVC / 5-25 m	PVC-cable, 5-pin, length 25 m

PVC-cable with M12-connection, brass nickel-plated, IP 67, shielded

M12-PVC / 4G-5 m	PVC-cable 4-pin, length 5 m
M12-PVC / 4G-10 m	PVC-cable 4-pin, length 10 m
M12-PVC / 4G-25 m	PVC-cable 4-pin, length 25 m
M12-PVC / 5G-5 m	PVC-cable, 5-pin, length 5 m
M12-PVC / 5G-10 m	PVC-cable, 5-pin, length 10 m
M12-PVC / 5G-25 m	PVC-cable, 5-pin, length 25 m

M12-K / 4	M12-connection 4-pin, IDC technique, with plastic knurled screw
M12-K / 5	M12-connection 5-pin, screw connection, with plastic knurled screw

PVC-cable with M12-connection



Options

CERT / 2.2 / FMI	factory certificate 2.2 as per DIN EN 10240 for FMI
CAL / FMI	standard factory calibration certificate (2 calibration points)
CAL / FMI / MP	multipoint factory calibration certificate (4 calibration points)